

OPERATING INSTRUCTIONS

Integraline GG

ULUF P390GG / P500GG / P610GG / P820GG



TABLE OF CONTENTS

INTRODUCTION 4

Symbols	4
Abbreviations	4

SAFETY 5

Intended use	5
Personal safety	5

HANDLING & TRANSPORTATION 6

Moving the unit	6
Packaging	6
Unpacking	6
Inactivity for extended period	6
Disposal	6

INSTALLATION 7

Preparing the unit	7
Refrigerant	7
Location	7
Electrical connection	8
Getting started	9

PRODUCT DESCRIPTION 10

Cabinet overview	10
Cabinet details	11
Cabinet description	12
Probes and portholes	13
Dual cooling technology	13
Filterless construction	13
Remote alarm contact	13
Vacuum valve	14
Display	15

▶ Keyboard	15
▶ Action icons	16
▶ Info events	16
▶ Door warning	16
▶ Temperature alarms	17
▶ Failure events	17
▶ Compressor failure alarm	18
▶ Outcome frames	18
▶ Warnings	19
▶ How to turn on device	20
▶ How to turn off device	20
▶ Menu user	21
How to change the setpoint	22
How to change alarm limits	22
Access log	23
Ecomode settings	23
Event list	24
Graphs	24
▶ Menu settings	26
How to set date/hour	27
How to change language	27
Password settings	27
Alarm test	28
Machine name	28
Default settings	29
Data download	29
Open and process data on a computer	30
Rating plate	31
Description of data points	31

MAINTENANCE 32

General maintenance	32
Cleaning	32
Defrosting	33
Service	33
Spare parts	33

AFTER SALES 33

WARRANTY 33

TROUBLE SHOOTING 34

INTRODUCTION

Please take a few minutes to read and become familiar with the advantages of your unit. To meet the high quality demands required by the medical and pharmaceutical industry, at least 10% of all units that leaves Arctiko are carefully checked and tested to ensure high performance and quality. If the operating and installation instructions describe different models, any differences will be pointed out at the relevant points in the text. Read these operating and installation instructions before switching on the unit.

If you would like to obtain further information about this unit, please visit our website www.arctiko.com where downloads are available on the page of each specific product.

SYMBOLS



WARNING

Performing this action can cause injury.



CAUTION

Risk of personal or material injury. Consult the instructions before attempting to use this equipment.



Prohibition

Action is strictly prohibited.



Follow procedures

Keep the instructions handy for convenient reference.



OFF

Disconnect from power outlet before operation.



WARNING Flammable material

This unit contains flammable refrigerants.



Grounding

Be aware that the unit is grounded.



Fragile

Handle with with care. Indicates a device that can be damaged or broken if not handled with care.

ABBREVIATIONS

SYMBOL	DESCRIPTION
A	Amps
W	Watts
V	Voltage
°C	Degrees Celcius
H	Hour
Min	Minutes
MM	Millimeters
Kg	Kilograms
N/A	Not applicable
ULT	Ultra-low temperature

SAFETY

Arctiko is obligated as a supplier to ensure the users safety when operating one of our units. To prevent personal and material injury or damage, please follow the instructions in this manual.

INTENDED USE

Ultra-low temperature units are designed for storage of biomedical products at a constant temperature in clinical, pharmaceutical, research and laboratory fields, and can also be used for commercial use. The units are designed to operate within a temperature range of -40°C to -86°C at a maximum ambient temperature of 32°C. For safe and optimal performance of the unit, it should only be placed indoors, in a well ventilated room and in elevations below 2000m. The unit should only be operated by instructed personnel.

PERSONAL SAFETY

When operating an ultra-low temperature freezer, you are exposed to a variation of possible dangerous events.

- Read and understand this manual. If in doubt, contact your local Arctiko distributor.
- Use freezer gloves at all times when loading or unloading the unit. The temperature of operation is such that direct contact with the cold contents or inside the unit can burn unprotected skin.
- Assure good cleaning practices at all times by keeping the unit and the adjacent areas clean, dry and uncluttered.
- Do not store explosive substances such as aerosol cans with a flammable propellant inside the unit.



Prohibition

Do not insert metal objects such as pins or wires into any vent, gap or outlet on the unit. This may cause electric shock or injury by accidental contact with moving parts.



WARNING

Do not use mechanical devices or other means to accelerate the defrosting process, other than those recommended by the manufacturer.



WARNING

Do not damage the refrigerant circuit.



WARNING

Do not use electrical appliances inside the food storage compartments of the unit, unless they are of the type recommended by the manufacturer.



Follow procedures

When removing the power plug from the outlet, pull on the plug, not the cord. Pulling the power cord may result in electric shock or fire by short circuit.



WARNING Flammable material

This unit contains flammable refrigerants.

HANDLING & TRANSPORTATION

MOVING THE UNIT

Lifting, moving and transporting the unit without suitable equipment may cause personal injury or material damage. Always use suitable lifting equipment to load, unload and move the unit.



OFF

Disconnect from the power outlet before moving the unit. Make sure not to damage the power cord. A damaged power cord may cause electric shock or fire.



Follow procedures

Be careful not to damage the unit during transport.

PACKAGING

- Do not expose the package to rain.
- Always keep the package upright. **DO NOT BRING THE PACKAGE TO A HORIZONTAL POSITION.**
- Do not expose the package to bumps and shocks.
- Package contents are fragile.

UNPACKING

1. Inspect the packaging carefully for any damage that may have occurred during shipping. If damage is observed, report to the shipping company and your local Arctiko distributor.
2. Remove all packaging material, plastic and straps. All packing materials are entirely recyclable. For more information on where to dispose of waste, contact your local authority or recycling station.



Prohibition

Plastic bags pose a suffocation risk.
Keep away from children.

INACTIVITY FOR EXTENDED PERIOD

If the unit must be switched off for a longer period and stored away, take the following precautions:

- Clean the unit both inside and outside.
- Ventilate the unit and make sure it is completely dry.
- Disconnect from the power outlet.
- Leave the door slightly open in order to prevent rot and mold.



OFF

Disconnect the unit from the power outlet when it is not in use for a longer period.
Keeping the unit plugged in may cause electric shock, current leakage or fire due to the deterioration of insulation.



Follow procedures

If the unit is to be stored unused in an unsupervised area for an extended period, **ensure that children do not have access and that doors cannot be closed completely.**

DISPOSAL

In the event of disposal of the unit, observe relevant legal regulations to prevent harmful environmental effects.

Within the European community, EU directives regulate disposal of electrical devices.

This unit is marked in compliance with the 2002/96/CE European Directive, WASTE ELECTRICAL AND ELECTRONIC EQUIPMENT (WEEE).



OFF

Disconnect power supply before operation.



CAUTION

Risk of personal or material injury during disposal of components.



WARNING Flammable material

This unit contains flammable refrigerants.

INSTALLATION

PREPARING THE UNIT

- **Unpack the unit:** Remove all packaging materials, plastic bags and straps.
- **Storing the key:** The key for the door lock is strapped to the backside of the unit. Remove the key from the cable carefully without causing damage to the cable. Keep the key in a safe place.
- **Read the Quick Start Guide:** The Quick Start Guide is provided with the unit.
- **Ventilate the unit:** Open the door for at least 20 min, in order to ventilate the unit before first use. The unit may contain odors from manufacturing.
- **Clean the unit:** Clean the unit on the inside and outside with a soft cloth/sponge using a solution of water and light detergent. After cleaning all surfaces of the unit, wipe the inside with a dry rag.
- **Remote alarm contact:** The terminals for the remote alarm contact are located on the backside of the unit (see *Cabinet description*). The contact design is a maximum load of 2A. The remote alarm contacts work in synchronization with the buzzer alarm on the unit. When an alarm is accepted on the display the remote alarm relay will return to normal. The remote alarm can be set as normally open (NO) or normally closed (NC).

REFRIGERANT

Please see the serial plate affixed to the unit, to obtain information about the refrigerant.

LOCATION

Place the unit in a location that complies with the following conditions in order to achieve optimal operating results:

- **Firm and levelled floor:** Installing the unit on a firm and flat floor reduces the risk of excessive noise and vibration.
- **Away from any heat sources:** Avoid placing the unit near any heat dissipating devices such as a gas burner/stove, radiator, oven or other source

of heat. Exposing the unit to heat will lower the performance.

- **Place the unit away from direct sunlight:** Placing the unit in direct sunlight may cause reduced performance and shorten the life expectancy.
- **Dry area:** Avoid placing the unit near damp areas such as water faucets and sinks.
- **Clean area:** Placing the unit in a clean environment will reduce risk of function failure. Avoid installing the unit in or near chemicals and materials that might have outgassing property to avoid corrosion.
- **Well ventilated:** There must be sufficient space around the unit to ensure air ventilation. Lack of such space will reduce the cooling capability of the unit. Place the unit with at least 10 cm free space to each side and 15 cm behind the unit.
- **Do not place any objects on top of the unit.**

Min. room size (A) for installation:

UNIT	CHARGE PER CIRCUIT (G)	A (m ²)
P390 GG	149	None
P500 GG	190	4.55
P610 GG	219	5.24
P820 GG	270	6.46



WARNING

An electrical power plug with a ground connection must be used to power the unit.
This is to prevent electrical shock.



Prohibition

Do not use the unit outdoors. Current leakage or electric shock may result if the unit is exposed to rain.



Never install the unit in a flammable or volatile location. This may cause explosion or fire.



Install the unit on a sturdy floor and take an adequate precaution to prevent the unit from tipping.

ELECTRICAL CONNECTION

In order to ensure an economical and reliable installation that complies with the limits of temperature and voltage drop, it is necessary to determine maximum load of units connected to the installation. In determining the maximum load for an installation or for a part of it, it is vital to take into account contemporaneous factors.

For supply systems, the following must be determined:

- Power system (AC/DC): Data regarding voltage and absorbed power/current is given on the rating plate.
- Ground protection: To prevent the user of getting exposed to electrical shock, in the event of a insulation damage, the unit must be grounded.
- The installation must always be secured with a minimum 10A fuse.
- If you have more than one unit, each unit must be connected to an individual fuse group.

When installing the unit, make sure the protected earth is grounded. If the connection is a 3-pole connection, use a three-pin plug and connect the conductor with yellow/green insulation to ground. In order to maintain a stable operation of the unit, voltage variation cannot differ more than $\pm 10\%$ of the nominal voltage supply.

Always follow local regulations when preparing an installation. Contact your local authorities if in any doubt.

Maximum current rating (Ambient 20°C):

UNIT	AMPS (A)
P390 GG	10
P500 GG	10
P610 GG	10
P820 GG	12

Maximum current rating (Ambient 32°C):

UNIT	AMPS (A)
P390 GG	11
P500 GG	12
P610 GG	12
P820 GG	12

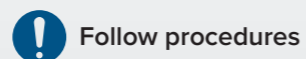

Only qualified/authorized engineers or service personnel should install the unit. Installation by unqualified personnel may cause electric shock or fire.

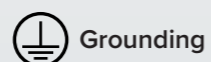

Always make sure the unit is grounded to protect the user from electrical shock.

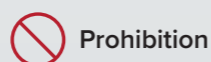

Do not use the power cord if it is damaged. Such supply cord may cause fire or electric shock.

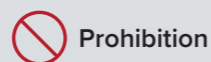

Never use a telephone line or lightning rod as ground protection. During lightning, there is a strong current present, which is extremely dangerous.



Do not use water pipes as ground protection. Modern water pipe systems are non-conductors such as PVC.

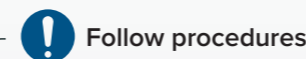

Replacing the power cord may only be done by authorized personnel.

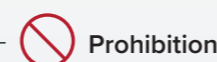

Never use gas lines as the ground protection for the unit. This can cause an explosion.



Disconnect the power cord if there is something wrong with the unit. Continued abnormal operation may cause electric shock or fire.

unit. Products should be pre-frozen when inserted into the unit, otherwise this can affect the cooling performance of the unit.

GETTING STARTED

During the initial startup and continuous usage of the unit, the following procedures shall be followed:

1. Plug the power socket in a dedicated outlet. For correct voltage requirement, follow the information on the rating plate. When started, let the unit cool for 24 hours before placing any products in it.
2. When the unit initially starts up, the buzzer alarm may sound. This is normal. You can accept the alarm on the display.
3. This unit has been set to operate at -80°C from the factory.
4. Check the functionality of the light by opening the door.
5. Once a thorough inspection of the unit is completed, products can be loaded into the

PRODUCT DESCRIPTION

The Integraline range offers the best ultra-low temperature freezing with high performance and stability. Standard features are noise reduction technology, dual cooling system, VIP panels, air flow control, filter-less construction for less maintenance, low noise level, low energy consumption, low heat

dissipation and excellent temperature stability. The compressors and cooling system is located in the top of the unit for easy maintenance and access, ergonomically correct work position and less generation of heat in your working area.

CABINET OVERVIEW



CABINET DETAILS

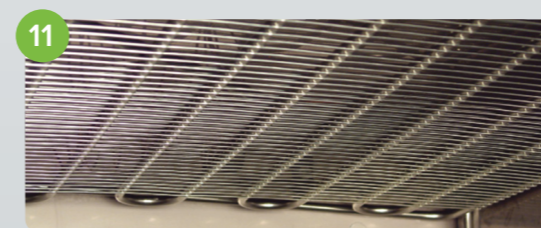
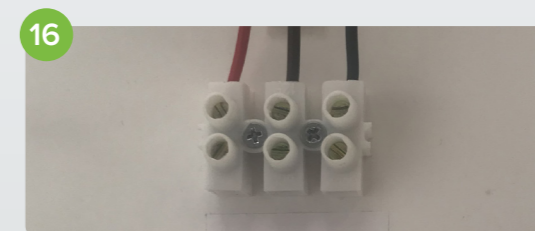
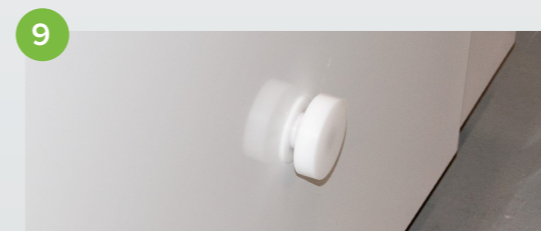
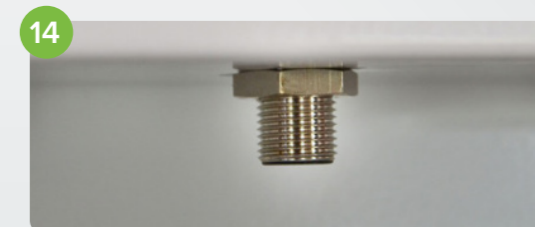
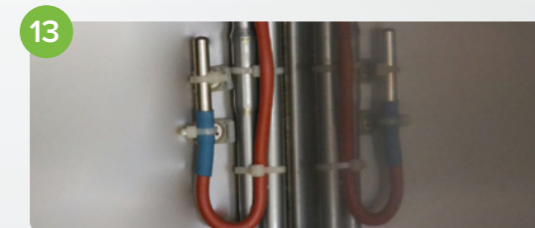
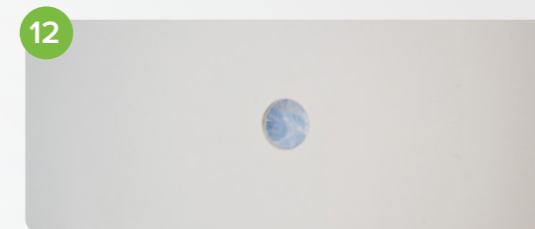
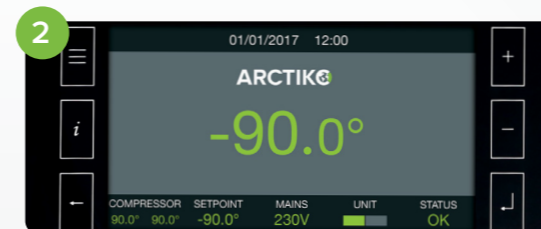

CABINET DESCRIPTION

NO.	AREA	DESCRIPTION
1	Top panel	Compressor compartment lid, fitted with control panel.
2	Display	See <i>display</i> .
3	LED light	Secure work light.
4	Door switch	Monitors the door openings and control the lights.
5	Probe	See <i>Probes and portholes</i> .
6	Door handle with lock	For easy opening, closing and locking the door.
7	Heated door frame	Prevents ice build up on door.
8	Inner doors	Removable inner doors.
9	Vacuum valve	Equalizes the pressure in the unit.
10	Adjustable shelves	Shelves that are easy to adjust.
11	Fixed shelf	This shelf cannot be adjustet.
12	Castors	2 pcs. in front with brake, 2 pc. back without brake.
13	Portholes	See <i>Probes and portholes</i> .
14	Evaporators	Provides a constant temperature in each compartment.
15	Cover for noise reduction and air flow management	-
16	Remote alarm connection	For connecton of additional alarm equipment.
17	Top panel latch	For opening and closing the top panel.
18	Compressor compartment	The compressor compartment is located in the top of the unit.
19	Racks and boxes	Optional equipment (racks and boxes).

PROBE AND ACCESS PORTS

As standard, the unit is equipped with a temperature probe inside the chamber. The probe monitors the temperature in the chamber and controls the operation of the compressors.

The main probe also controls temperature alarms. It is possible to connect two different probes to the unit in order to monitor the temperature different places in the unit. You can change the settings on which probe is the main probe.

To install more probes, you can use the premade access port(s) on the back of the unit. Carefully push a screwdriver or similar through the holes. Always seal the holes with putty on both sides of the hole.

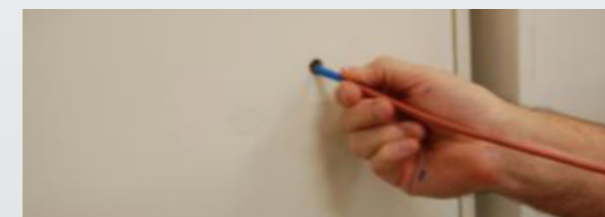

! Follow procedures

Never install probes through the door as this will deteriorate the functionality of the door gasket, increase the ice build-up and affect the temperature inside the unit.

DUAL COOLING TECHNOLOGY

Our Integraline models ULUF P390GG / P500GG / P610GG / P820GG comes with dual cooling system. The dual cooling system offers two independent cooling cycles and thereby optimal security of your stored products in the unlikely event of failure in one of the cooling cycles. In case of failure, the other cooling cycle will serve as a backup, guaranteeing that your stored products will be kept at a safe temperature.

FILTERLESS CONSTRUCTION

Arctiko's dual compressor system is designed as a filter-less system, which prevents malfunctions caused by dust build-up in the filter. This minimizes the maintenance of the cooling system and secures a more stable operation.

REMOTE ALARM CONTACT

The remote alarm contact is located on the backside of the unit.

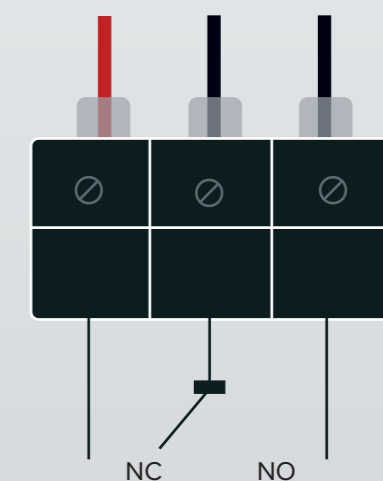

VACUUM VALVE

The vacuum valve helps equalize the pressure inside the unit, which allows the user to open the door without waiting for hours.

! WARNING

The vacuum valve requires regular attention and cleaning to be fully operational. Misuse could cause the unit to be inaccessible for up to three hours.

! WARNING

Regular cleaning and ice removal is necessary to maintain full function of the vacuum valve. The cleaning frequency depends on different conditions such as the number of door openings, ambient temperature and humidity at the installation site.

Recommended cleaning procedures

It is important to clean the valve regularly. It is recommended to clean the valve every second week or in case of ice build-up.

1. To clean the valve, pull it out from the exterior side of the door as shown on the illustration below (no tools are required):

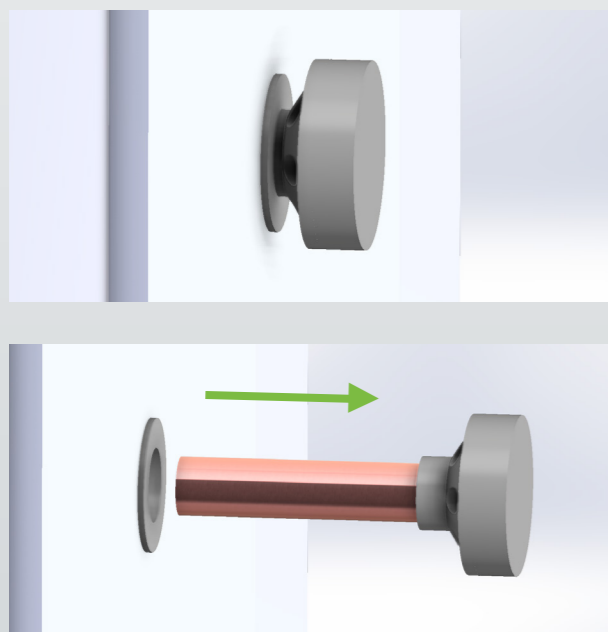

2. Rinse the valve on the exterior side with cold tap water for 2 to 5 minutes or until all ice inside the valve is removed. Make sure the vacuum valve is completely dry before inserting it into the tube and be aware that it is inserted correctly (push it firmly until it clicks in).

It is recommended to remove ice build-up around the vacuum valve on the interior side of the unit regularly as well as ice removal from the inner doors and gaskets is recommended to maintain the performance of the unit and the vacuum valve.

3. Before inserting the vacuum valve into the tube in the door, assess the O-ring for any damage or misplacement. Make sure to pull the O-ring all the way to the end, like in the illustration below:

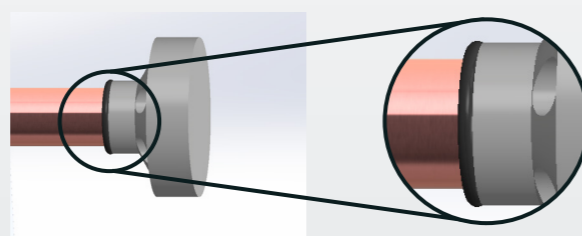

The vacuum valve is removed but the door cannot open

If the door cannot open after removing the vacuum valve from the tube in the door, the tube may be blocked by ice. Carefully use the enclosed key to remove the ice (do not use sharp objects) and clear the passage.

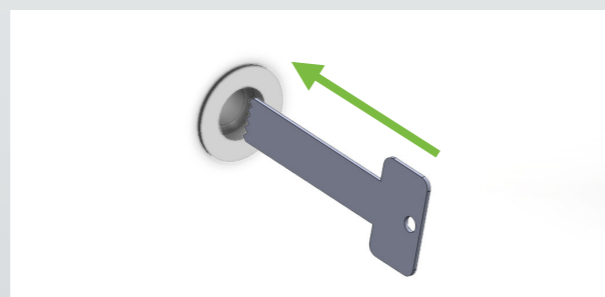

See "Recommended cleaning procedures" to learn how to maintain the vacuum valve. This will reduce the risk of ice build-up in the tube in the door.

DISPLAY

Easy and user-friendly control panel, with a 6-key resistive keyboard. You can access a variation of settings, in order to adjust your unit for your exact needs. A 4GB microSD is provided as standard, installed internally for recording functional data every 30 seconds with a memory capacity of about 10 years.

In the single temperature configuration two types of Home Page are provided: EASY or SCIENTIFIC. The external ESCAPE key selects one mode or the other. The header shows the MACHINE_NAME (in the example LABORATORY) that can be edited from the SETTINGS MENU.

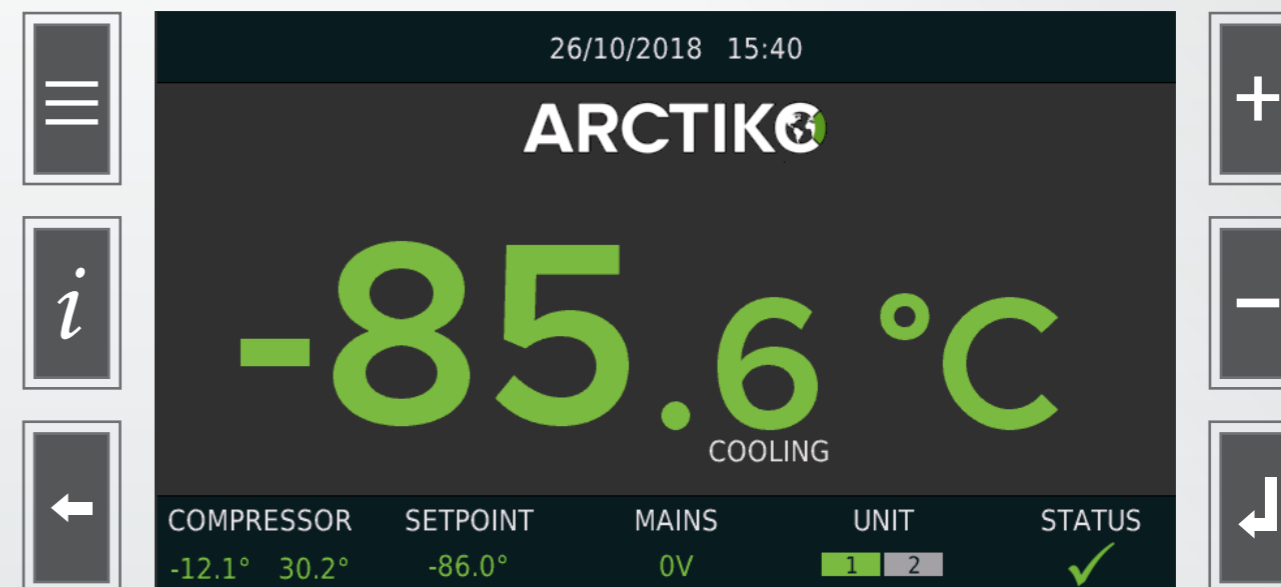

SYMBOL	KEY	DESCRIPTION
	MENU KEY	Accesses the menu panel.
	INFO KEY	Accesses the info pages from Home Page level.
	ESCAPE KEY	Goes to previous level. Switch between <i>easy/scientific Home Page</i> .
	UP KEY	Increase value of selected parameter. Select multi-page menu.
	DOWN KEY	Decrease value of selected parameter. Select multi-page menu.
	ENTER KEY	Store the selected value.

► ACTION ICONS

ICON	ACTION
no icon	PAUSE
	WAITING COOLING
	COOLING
	DEFROST
	DRIPPING
	HEATING
	WARM
	DRY
	CO2 BACKUP
	STOP ACTIONS

► INFO EVENTS

ICON	EVENTS
	ALARM ON
	FAILURE STATUS
	NOTIFY

► DOOR WARNING

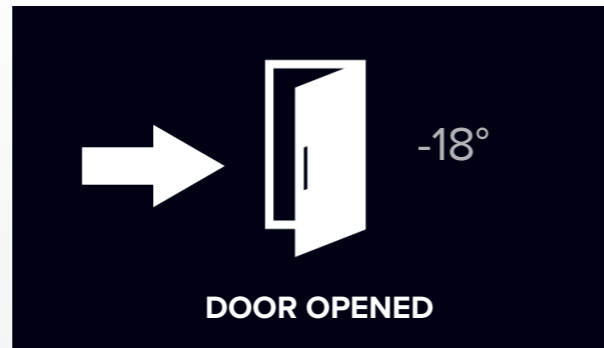

► TEMPERATURE ALARMS

LOW/HIGH TEMPERATURE PREALARM



ALARM OCCURRED

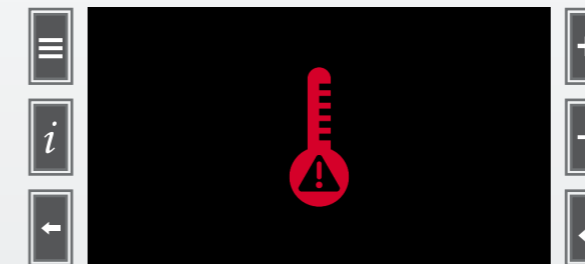

HIGH TEMPERATURE ALARM



LOW TEMPERATURE ALARM

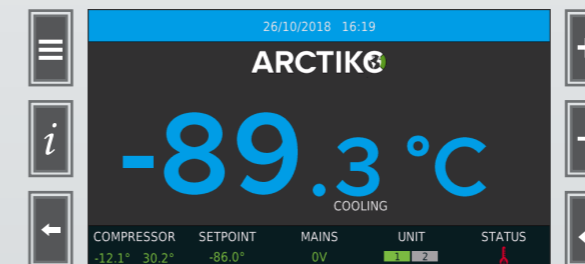

► FAILURE EVENTS

FAIL OCCURRED

1. To accept a failure, press the center of the screen.

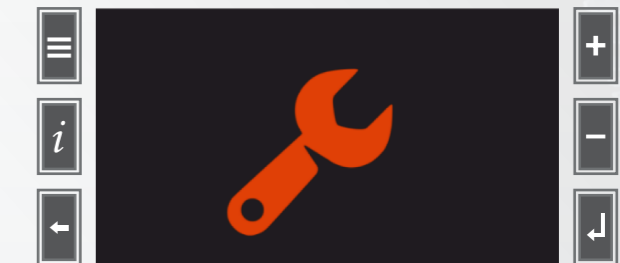

2. Jump to EVENT LIST to check the failure.

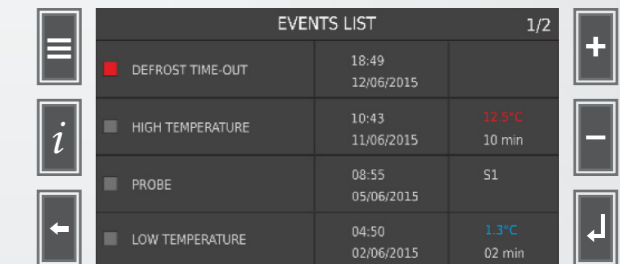

3. In case of a unresolved failure, the icon FAIL UNRESOLVED will be shown on the screen.

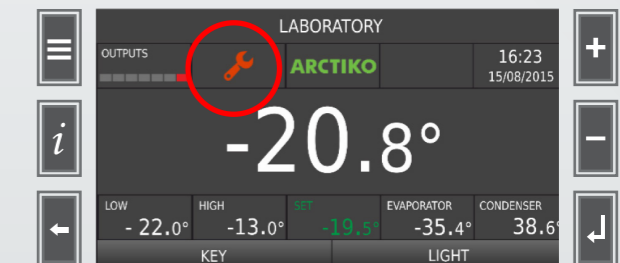

4. If any alarm has occurred, the icon NOTIFICATION OF PREVIOUS ALARM will appear on the screen.

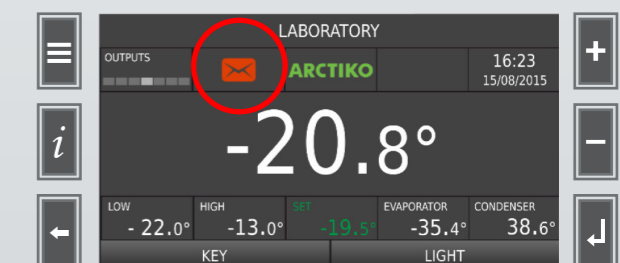

► COMPRESSOR FAILURE ALARM

The controller is equipped with a compressor failure detection feature. If the controller detect an unusual temperature profile on one of the compressors it will disable that compressor and activate an alert on the controller. The other compressor will keep running.

To reset the alarm and reenble the compressor; accept the alarm and turn the unit off and on again. During pulldown this alarm may be activated. If this happens please reset the alarm. If the alarm keeps reoccurring please contact your distributor or Arctiko service for help.

COMPRESSOR FAILURE ALARM OCCURED

1. To accept a failure, press the center of the screen.



2. Jump to **EVENT LIST** to check the failure.

EVENTS LIST			1/2
COMPRESSOR FAULT	18:49 12/06/2015	k1	
LOGIC FAILURE	10:43 11/06/2015	1 <-> 2	
HIGH TEMP. AFTER BLACKOUT	08:55 05/06/2015	19.8 c 0 m	
COMPRESSOR FAULT	04:50 02/06/2015	k1	

3. If any alarm has occurred, the icon **COMPRESSOR FAILURE ALARM OCCURED** will appear on the screen.

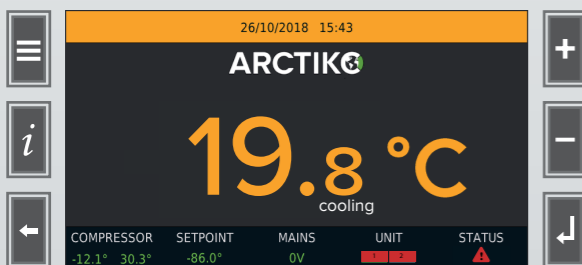

► OUTCOME FRAMES

The outcome frames will be accompanied by a long beep.

ERROR



INVALID VALUE

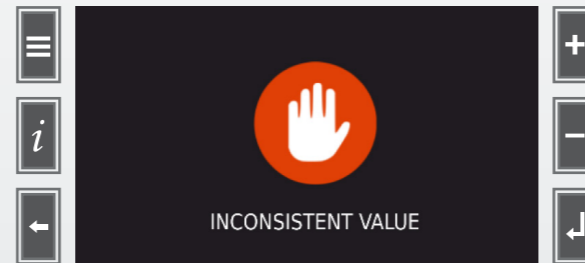

CONFIRMED

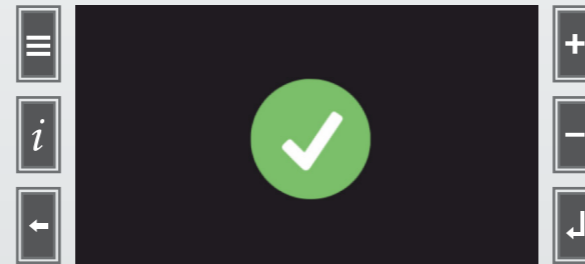

ESC/CONFIRM

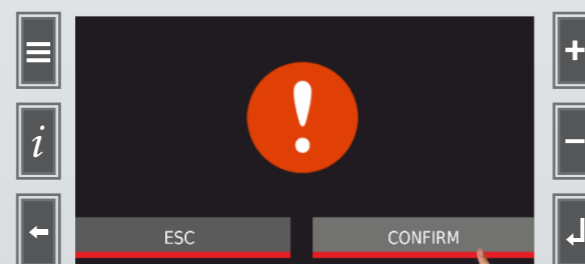

► WARNINGS

To accept a warning press **ENTER**.

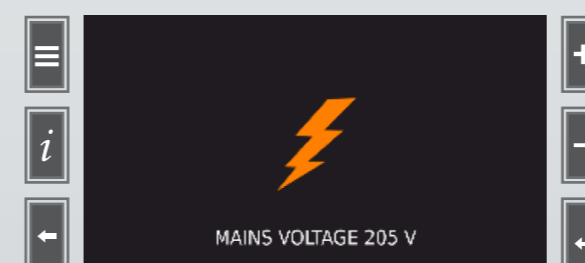
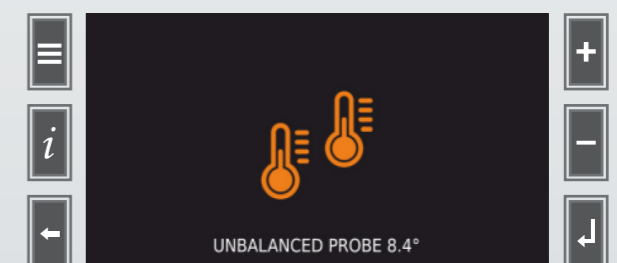
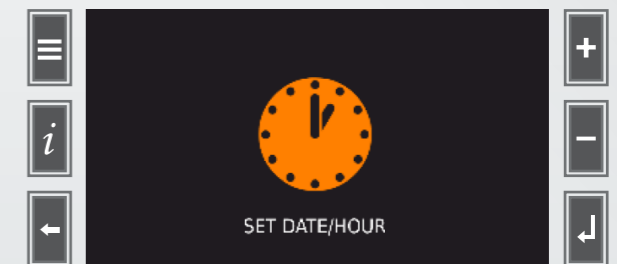
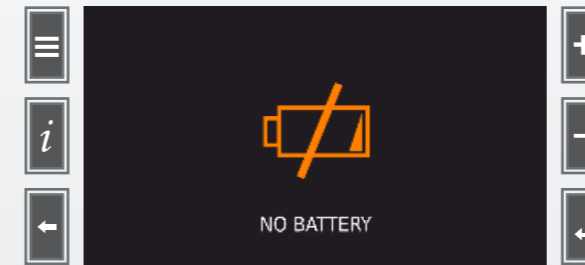
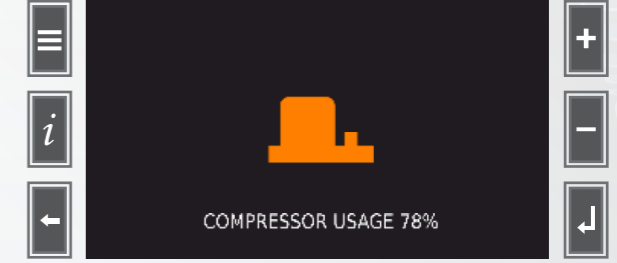
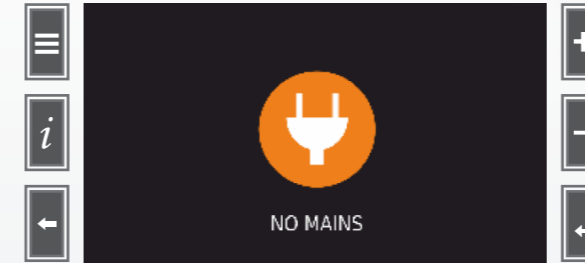

► HOW TO TURN ON THE DEVICE

1. Press on the **screen** and hold, to turn on the device.



2. If password protection is enabled, type password and press **ENTER**.

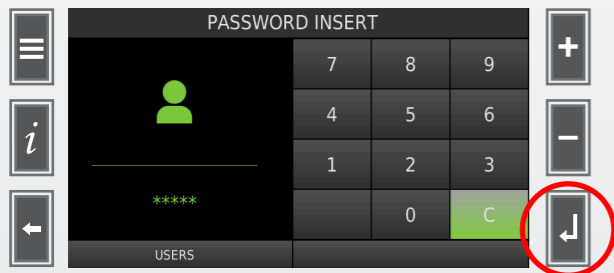

3. The main screen should appear.

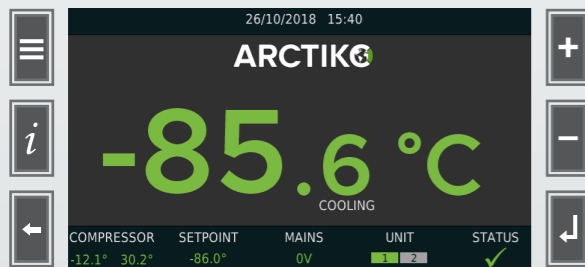

► HOW TO TURN OFF THE DEVICE

1. Press **MENU** to access the USER MENU.

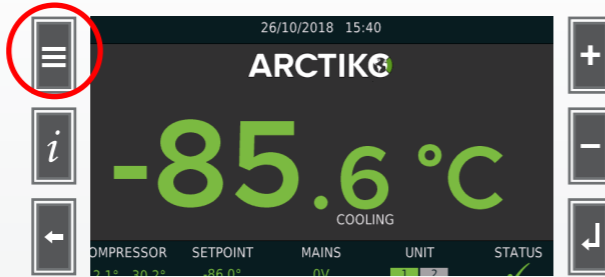

2. Press and hold **STANDBY** to turn off the device (put in standby mode).

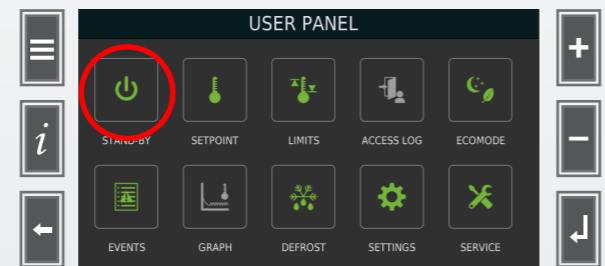

3. If password protection is enabled type password and press **ENTER**.



4. The standby mode should appear.

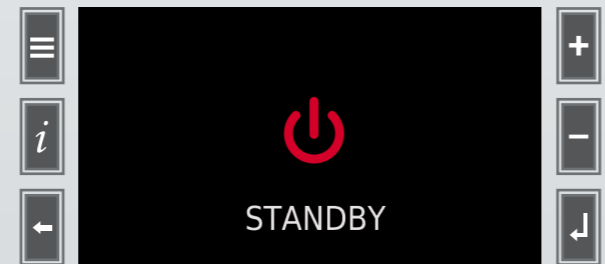

► MENU USER

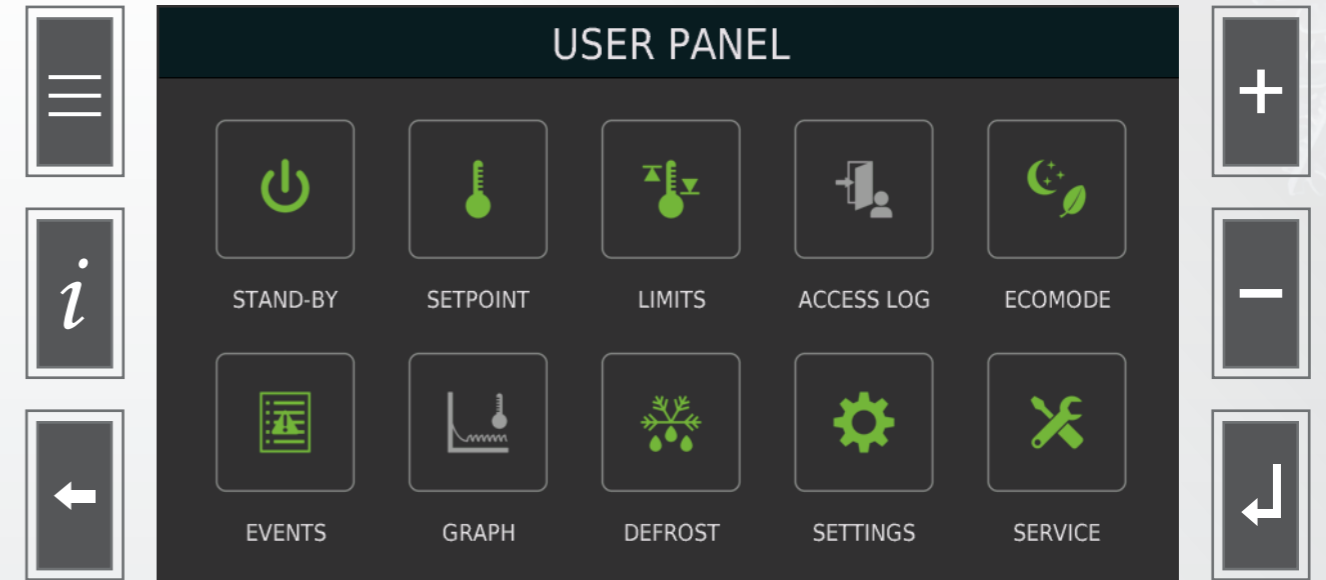

ICONS	DESCRIPTION
STAND-BY	Press and hold to turn off the controller.
SETPOINT	Change the temperature setpoint.
LIMITS	Set the high/low temperature limits and alarm delay.
ACCESS LIST	Access log.
ECOMODE	Set the ECOMODE parameters.
EVENTS	Displays the alarms and failures recorded.
GRAPH	Displays the daily temperature graph from calendar.
DEFROST	Start the defrost and displays temperature and time phase (defrost function not available on Integraline range).
SETTINGS	Access to MENU SETTINGS.
SERVICE	Access to MENU SERVICE.

How to change the setpoint

1. Press **SETPOINT** to enter the setpoint adjustment.



2. Press the **UP** to increase the temperature or the **DOWN** to decrease the temperature. Once the temperature has been set press **ENTER** to save the new value and exit.



3. In case you wish to recall values, press one of the following keys on the screen:

KEY	FUNCTION
STANDARD	Recall standard value
MIN	Recall minimum value
MAX	Recall maximum value
ACTUAL	Recall running value

4. Press confirm to accept the new values.

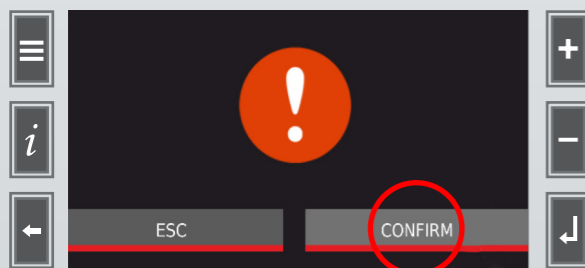

How to change the alarm limits

1. Press **MENU** to access the user menu.

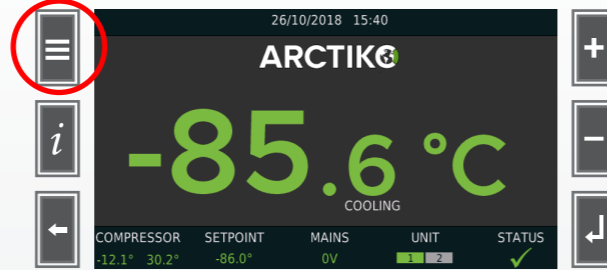

2. Press **LIMITS** in the user menu.

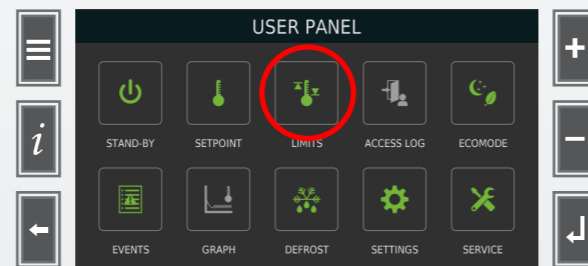

3. Key functions.

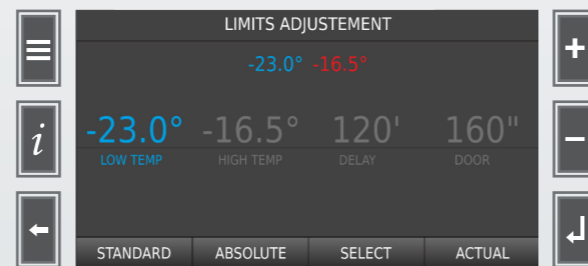

- **UP/DW** increases/decreases the value selected with the **SELECT** key.
- **STANDARD** sets the default value.
- **ABSOLUTE** sets in rotation the type of limit setting; the high and low temp. limits in the control board are always absolute. The calculated value of the limits is displayed under the panel title.
- **SELECT** enables in rotation the value to be set.
- **ACTUAL** retrieves the value in progress/preset.
- **ESCAPE** returns to the user menu without saving the map of values with confirm request.
- **ENTER** returns to the user menu saving the map of values with confirm request.

Access log

1. Press **ACCESS LOG** from user menu to access the display of the list of the last 32 events accesses.

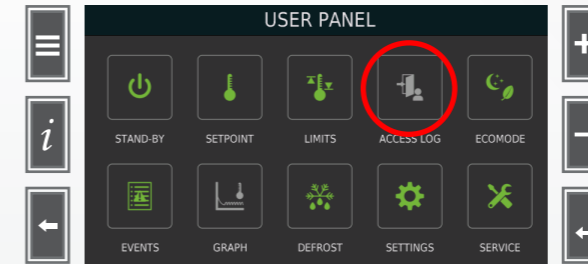

2. If you wish to consult previous logons make a **BACK-UP** data and open the contents of **USB** through the application **THERMO CONVERTER** where in the last 4 fields to the right are the records accesses with the description by means of the actions carried icons.

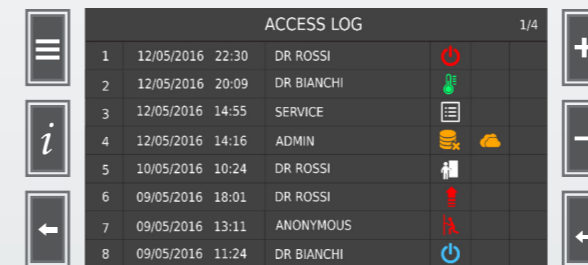

Description of the icons used in the access log:

- POWER OFF
- CHANGED SETPOINT
- CHANGED PARAMETER
- FORMATTED CARD
- DOOR OPENED
- CHANGED HIGH LIMIT TEMPERATURE
- BURGLARY
- POWER-ON

Ecomode setting

Press **ECOMODE** icon to displays the setting panel of the hourly or automatic temperature profile.

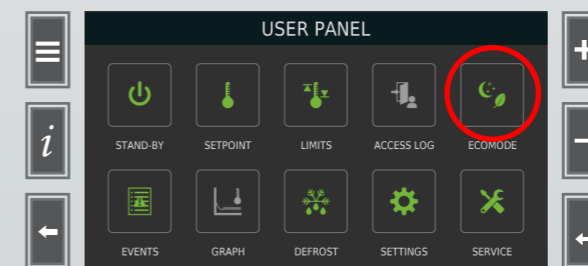

With **USER** password different from zero, it is requested to access the setting of the new configuration. The password is edited via the numerical keypad and confirmed by pressing **ENTER**. If the password was correctly set the **ECOMODE** frame is accessed, otherwise the **ERROR** frame appears and the display goes back to the **USER MENU**.

Press **UP/DW** to increase/decrease the value selected. The map of values is saved by pressing the external **ENTER** key with request to confirm.

ECOMODE OFF

Press **ON/OFF** to disables/enables **ECOMODE**; if the key is at **OFF** the other keys are disabled.

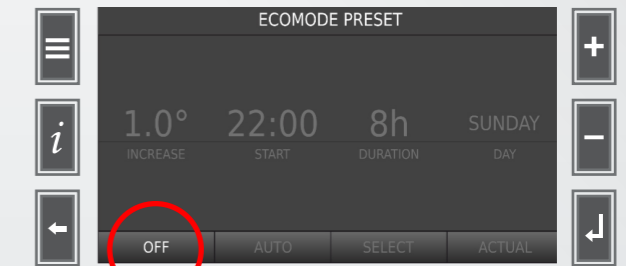

ECOMODE AUTO

Press **AUTO/TIMER** to set in rotation the **ECOMODE** **TIMER/AUTO** function; in **TIMER** mode the **SELECT** key is disabled and only the variable **INCREASE** is selected.

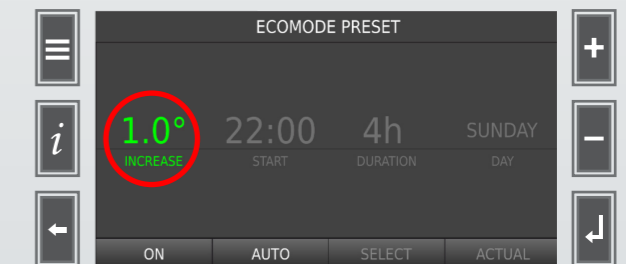

ECOMODE TIMER

Press **SELECT**, in **TIMER** mode, to enable the values to be set in rotation.

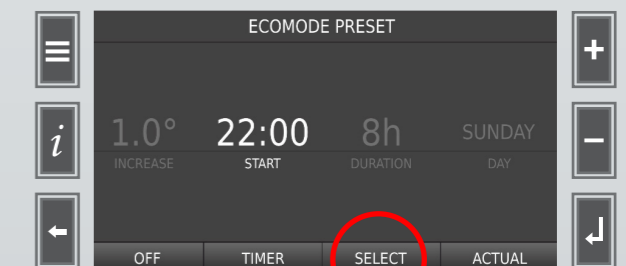

ACTUAL KEY

Press **ACTUAL/MODIFIED** to retrieve the value in progress/preset.

ESCAPE

Press external **ESCAPE** key to return to the USER MENU without saving with exit/confirm request.

Event list

The set of recorded alarms and faults are recorded and displayed in the EVENT LIST. Press **EVENTS** or the **INFO** key during an alarm/fault/notification status leads to the reading of the EVENT LIST.

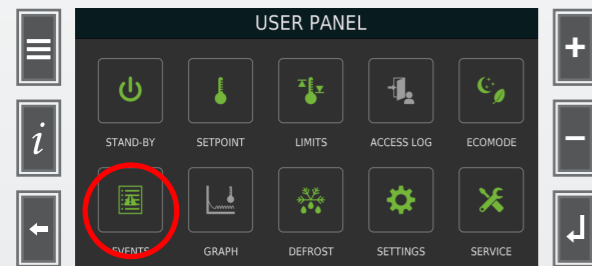

EVENT IN PROGRESS

Shows number of pages with events. Press the external **UP/DW** keys to change page.



EVENTS RECORDED

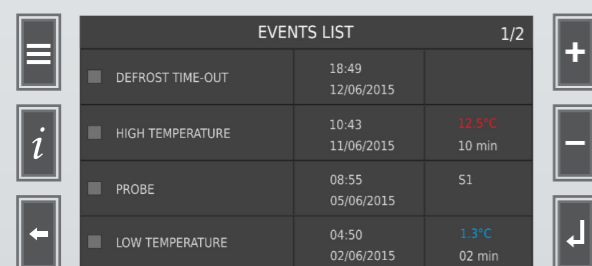

EVENTS LIST (ALARMS & DEFAULTS)

- HIGH TEMPERATURE
- LOW TEMPERATURE
- DOOR OPEN

- BLACK-OUT
- MAINS FAULT
- SX PROBE
- UNIT FAULT
- LOAD FAULT
- RELAY FAULT
- LOW EVAPORATION
- HIGH CONDENSATION
- HIGH PRESSURE
- DEFROSTING TIME
- FAULTY BATTERY
- DOOR SWITCH
- U1 RELAY FAULT
- U2 RELAY FAULT

EMPTY LIST

If the event list is empty, the following icon will be shown.

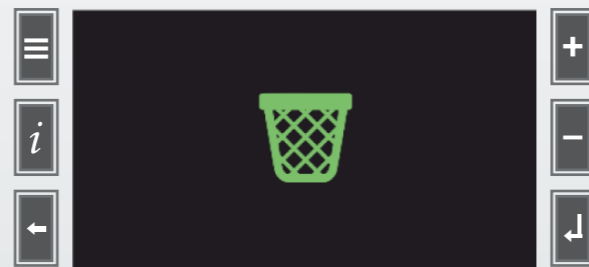

Graphs

Press **GRAPH** to access the select menu of the historical graph.

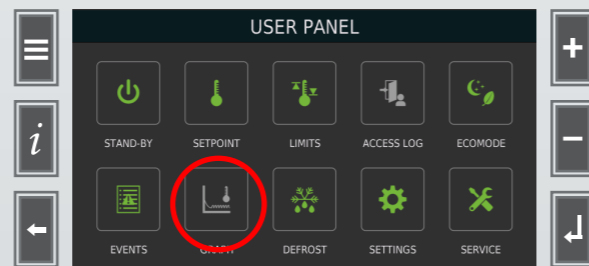

When the **CALENDAR** page opens, the selected day is the current one and it is highlighted by a white bar. Press **UP** to scroll the months forward and **DW** to scroll them back. Press **TODAY** to go back to the current day.

REPRESENTATION CRITERIA

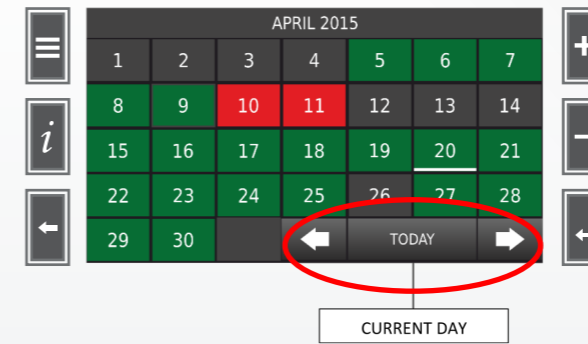

The grey boxes indicate the lack of data, the green boxes the presence of data, the red boxes the presence of a discrepancy. Press the key of the requested day to access the display frame of the daily graph.

SCROLLING THE GRAPH & ENABLING THE TRACES

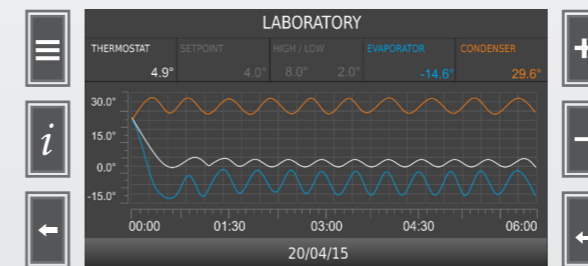

- The graph opens with start at 00:00 hours and ends at 06:00 hours.
- Pressing the external **UP/DW** keys - the time axis with 6-hour time slots - are scrolled forward/back.
- To select a different day, go back to the calendar by pressing **ESCAPE**.
- The temperature of the respective probes are traced enabling with a click the corresponding box; each square shows the average temperature values calculated in the 24 hours of the current day. The boxes from left allow the cyclic selection of the relative probes.

► MENU SETTINGS

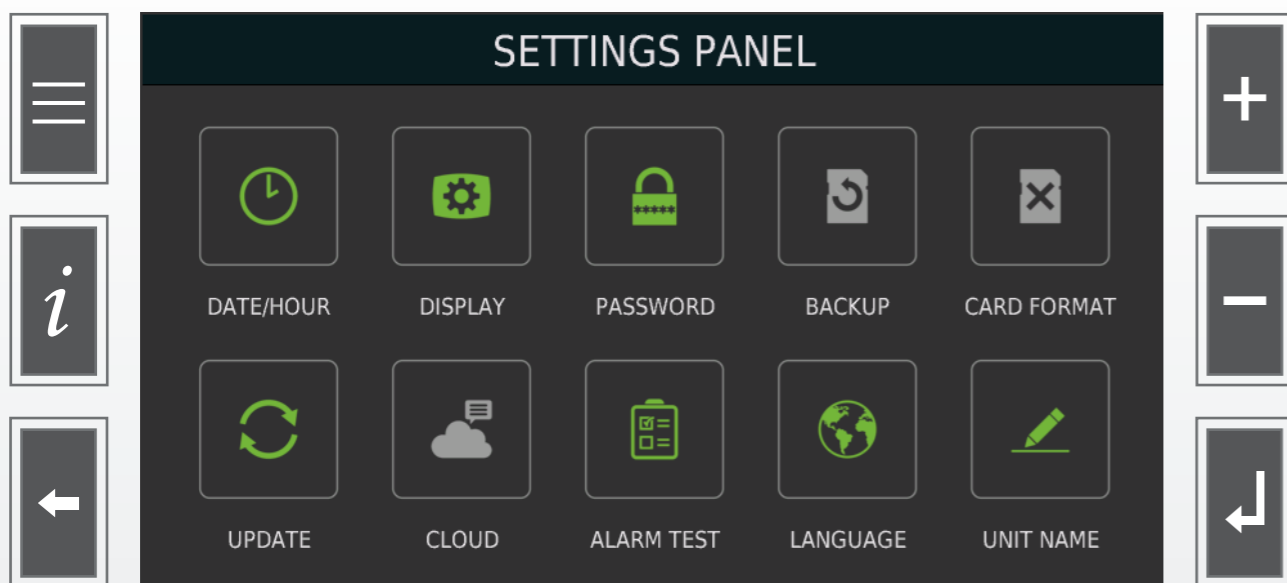

ICONS	DESCRIPTION
DATE/HOUR	Set the clock device.
DISPLAY	Set the configuration of panel display.
PASSWORD	Set the 3 levels of passwords: ADMINISTRATOR / USER / SERVICE
BACKUP	Start download data through USB port.
CARD FORMAT	Erase the data recorded.
UPDATE	Read and send setup files.
CLOUD	Set the LAN configuration.
SMS SETUP	Edit the telephone numbers where to send the alert messages.
LANGUAGE	Set the language of user interface.
MACHINE NAME	Edit machine name by alphanumeric keyboard.

How to set date/hour

1. Press **DATE/HOUR** to display the setting panel for the system date and time.

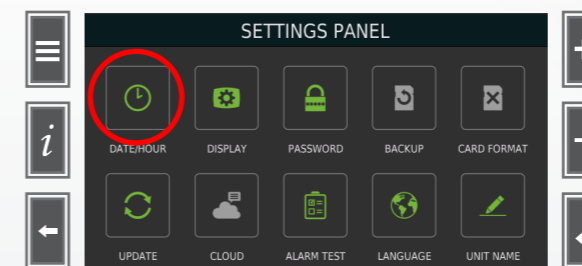

2. Press **SELECT** to move the highlight and use **UP/DW** to increase/decrease the value selected. The new date/time is saved by pressing the **ENTER** key with request to confirm.

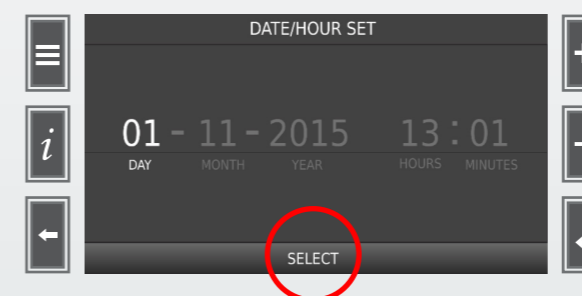

IMPORTANT!

- The system clock does not automatically manage the Summer time.
- The connection towards the Cloud refers to the transparent UTC at the nation time conventions.
- The navigation on the VELEX Cloud refers to the zone time conventions if the device used foresees its automatic management.

How to set language

Press the **LANGUAGE** icon to display the frame for selecting the text languages.

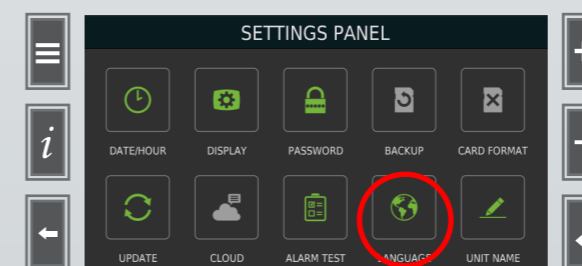

The language is selected in a mutually exclusive manner by clicking on the select box, which changes from grey to orange. Press **UP/DW** to browse the language setting page and save by pressing **ENTER** with request to confirm.

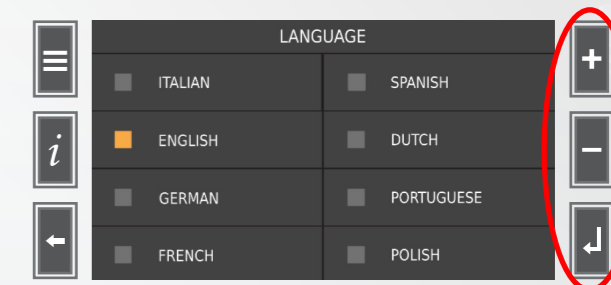

Password settings

1. Press **PASSWORD** to access the password settings.

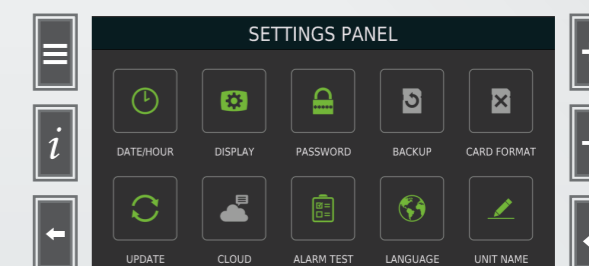

The passwords are used for limiting access to certain areas in the menus. There are 3 levels of access:

- User(s):** For setting basic parameters and turning the unit on or off. By default there is no password set.
- Admin:** For setting more advanced parameters and for managing users. The default password is "111".
- Service:** For accessing the service menu. The service settings are reserved for qualified Arctiko service personnel.

2. By entering the admin password both the admin and user passwords can be changed. The passwords can be deactivated by setting them to "000".

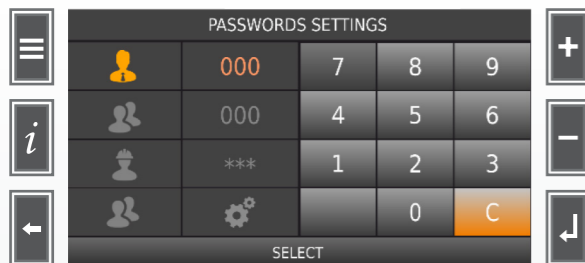

By entering the multiuser menu, multiple user accounts can be setup. This is useful for tracking which user changes parameters or turns the unit on or off. These individual user accounts can be named to easily differentiate between them.



Alarm test

1. Press **ALARM TEST** to start the alarm test.

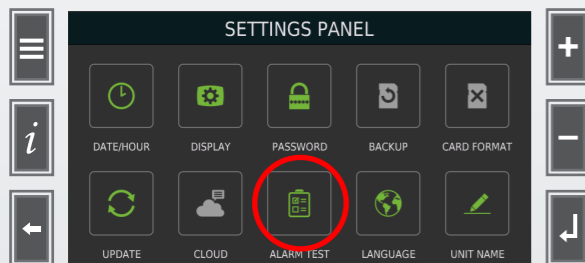

The icon pressure TEST starts the alarm test WITH the following sequences:

1. 3 seconds alarm icon with buzzer on

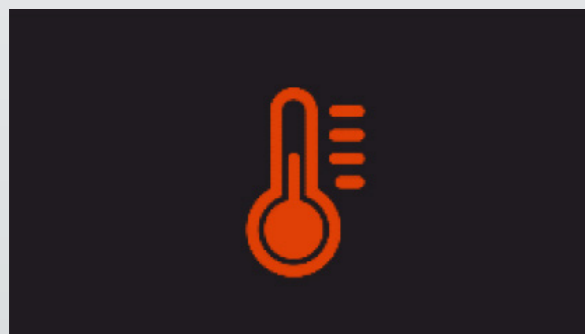

2. Activate the alarm relay for 3 seconds according to these sequences OFF / ON / OFF

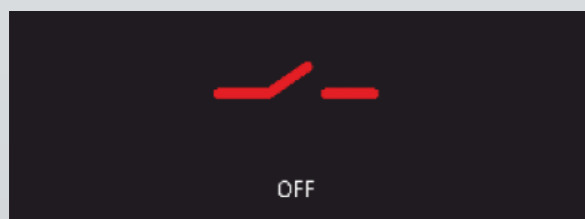

3. Back to Home Page

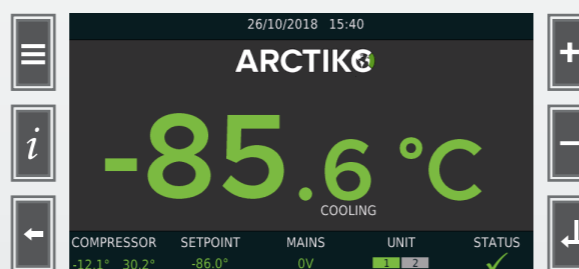

Machine name

1. Press **UNIT NAME** to display the editing frame of the machine name that is shown in the Home Page Header.

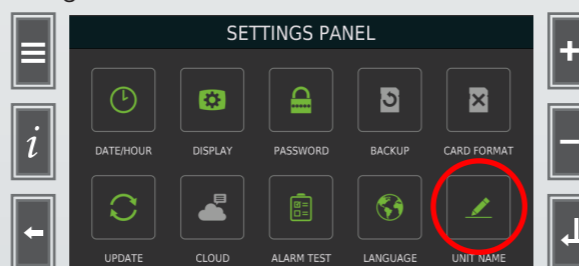

2. Fill out the desired name of max 24 characters and press **ENTER** to confirm.

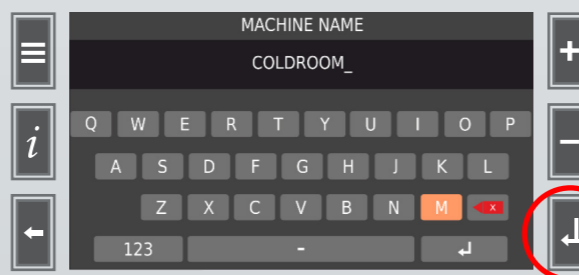

DEFAULT SETTINGS

CATEGORY	UNIT	DEFAULT SETTINGS
Limits (Alarms)	Low temp.	°C -99.0
	High temp.	°C -65.0
	Delay	Minutes 15
Setpoint	Door	Seconds 40
	Setpoint	°C -80.0
Display	Screensaver	Hours 0
	Buzzer	- ON
Ecomode	Ecomode	- OFF
Password	User password	- Deactivated by default
	Admin password	- 111

DATA DOWNLOAD

1. Press **BACKUP** to transfer the thermoregulation data on the USB pen.

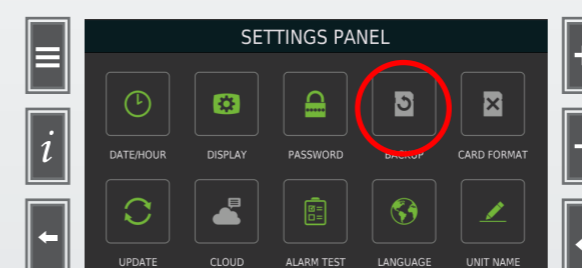

Follow procedures

ATTENTION! Do not remove the USB drive while transferring data. Wait for the ✓ icon to show before removing the drive.

2. Pressing **BACKUP** shows the USB pen insertion request frame with 20 second time-out. If the USB pen has been recognised, the setting page of the months to download is displayed, otherwise the display goes back to SETTINGS MENU.



3. Press **UP/DW** to increase/decrease the number of months to transfer; press **ENTER** to start the data download.

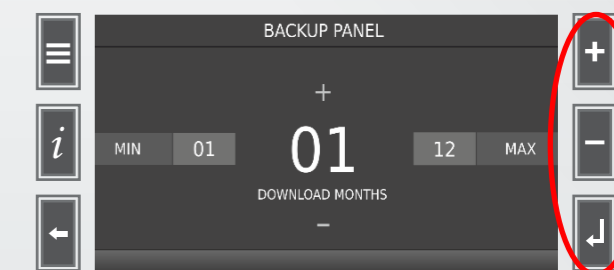

4. A progress bar will appear, wait for the download to complete or press **ESCAPE** to return to the setting menu without transferring the data.

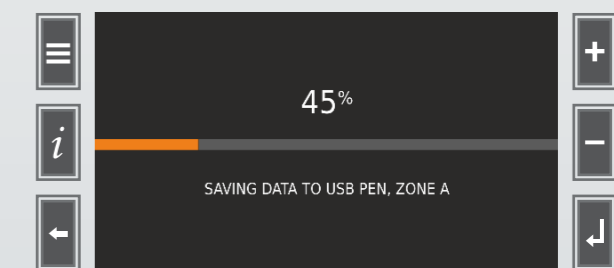

5. Once the data is downloaded the following sign will appear and the screen will return to settings menu.

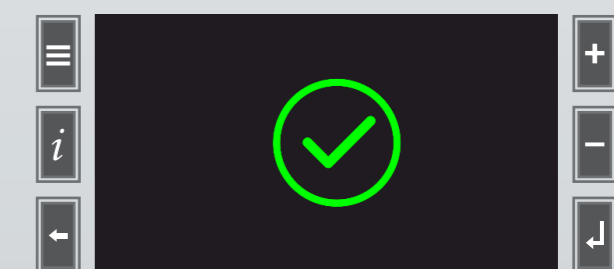

OPEN AND PROCESS DATA ON A COMPUTER

You can transfer the data to a computer in order to analyze, process or forward information. The program **THERMO CONVERTER** is needed to transfer the data. The program can be obtained by contacting your Arctiko distributor.

1. Insert the USB drive with the loaded data in a computer.
2. To convert the data, open the program **THERMO CONVERTER**. To convert the file press the **DAT TO CSV CONVERT** button.

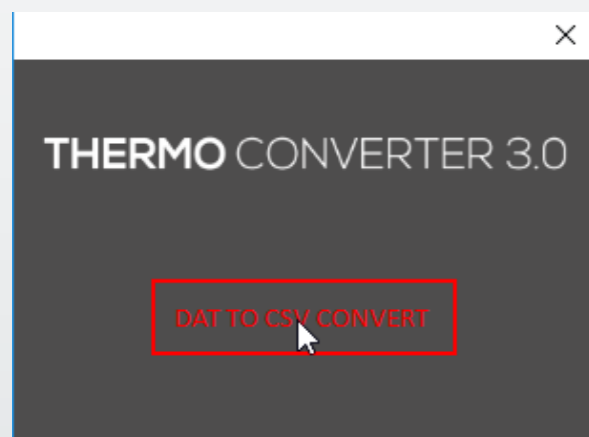

3. Open the file by following the path: **VLX > BACKUP > R00000 (serial number of the unit) > 201807 (year and month)**.

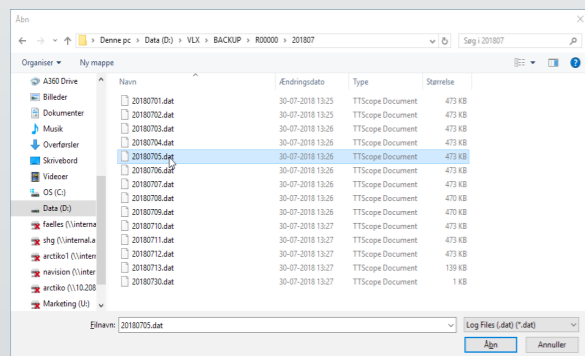

Choose the desired file and press **Open**.

4. When the conversion is complete, a window with the message "Successful operation" will appear. Press **OK** to continue.

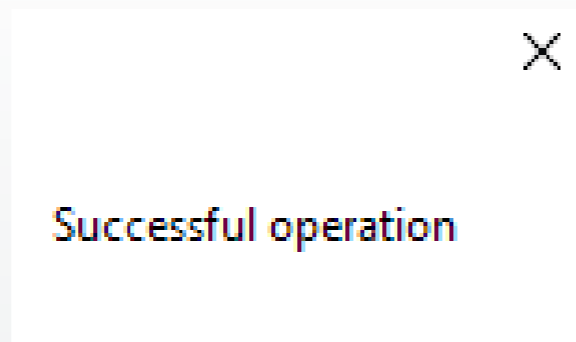

5. The file will now open in Excel or your equivalent program.

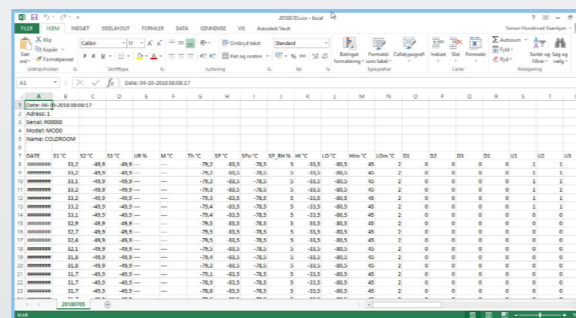

RATING PLATE

The rating plate is placed on the front right corner of the compressor department.

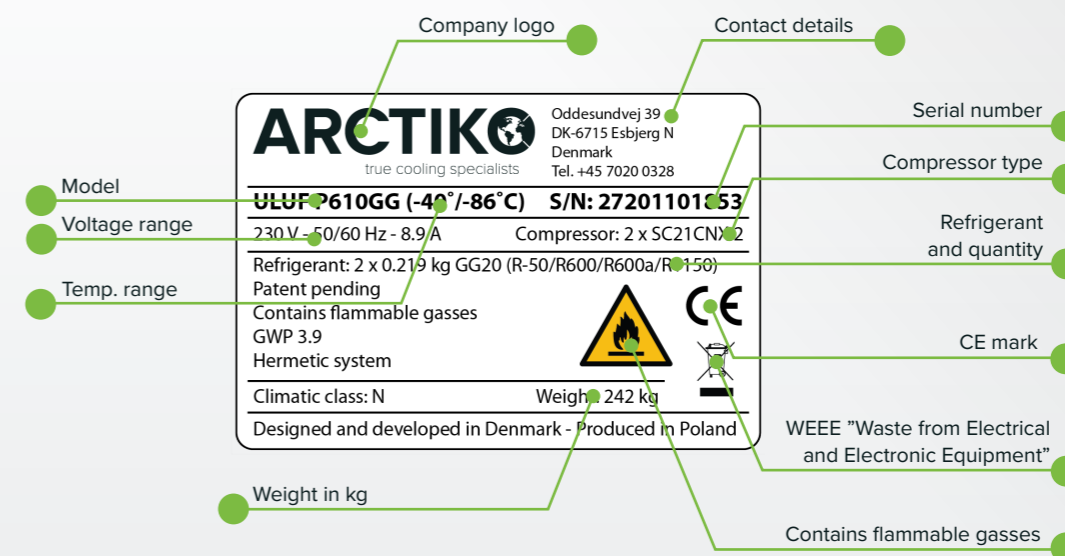

DESCRIPTION OF DATA POINTS

DATA POINTS	DESCRIPTION
SR	Refrigerator Serial Number
MR	Refrigerator Model
NM	Refrigerator Name
S1°C	NTC thermostat probe
S2°C	NTC evaporator probe
S3°C	NTC condenser probe
RH%	Humidity %
MONITOR °C	PT100M monitor probe
THERMO °C	PT100 thermostat probe
SET °C	Setpoint
SETo °C	Operational setpoint
SET_RH %	Humidity setpoint
HI TEMP °C	High temperature limit
LO TEMP °C	Low temperature limit
HI TEMPm °C	Monitor high temp. limit
LO TEMPm °C	Monitor low temp. limit
D1	D1 Digital input status
D2	D2 Digital input status
D3	D3 Digital input status
D1	Monitor D1 digital input status
RELAIS U1	U1 Relay status
RELAIS U2	U2 Relay status
RELAIS U3	U3 Relay status
RELAIS U4	U4 Relay status
RELAIS U5	U5 Relay status
RELAIS U6	U6 Relay status
LED BAR	LED output status
PCB °C	Technical compartment probe
Vin V	V board power supply

DATA POINTS	DESCRIPTION
MAINS Vac	Mains voltage
BATT %	Battery charge %
TEST BATT V	Battery voltage
DOOR STATUS	Door status
ACTIONS	Action in progress
ALARMS	Alarm in progress
ALARMS_m	Alarm in progress (monitor)
FAULTS	Fault in progress
FAULTS_m	Fault in progress (monitor)
WARNING	Warning in progress
WARNING_m	Warning in progress (monitor)
U1 %	U1 Relay use percentage
U2 %	U2 Relay use percentage
U3 %	U3 Relay use percentage
U4 %	U4 Relay use percentage
U5 %	U5 Relay use percentage
U6 %	U6 Relay use percentage
U7 %	U7 Relay use percentage
EH °C	Max evaporator calibration
EL °C	Min evaporator calibration
DELTA T °C	Thermal exchange
COMP 1h %	Compressor operation % (1h)
COMP 24h %	Compressor operation % (24h)
COMP ON	Time on compressor
COMP OFF	Time off compressor
COMP LIFE	Compressor total hours
VA	Power absorbed by loads
PASSWORD	User password
ACTION	Last user action

MAINTENANCE

Frequent and correctly executed maintenance is essential to ensure high performance and functionality of the unit. Arctiko recommends a thorough examination twice a year and cleaning at least once a month.

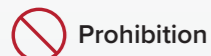

Prohibition

Never disassemble, repair, or modify the unit yourself. Any such work carried out by an unauthorized person may result in fire, or electric shock or injury due to a malfunction.



OFF

Before performing maintenance or cleaning the unit, **disconnect the unit from the power outlet.**



Follow procedures

Ensure that you do not inhale or consume medication or aerosols from the unit at the time of maintenance. These may be harmful to your health.



Prohibition

Never splash water directly onto the unit as this may cause electric shock or short circuit.

GENERAL MAINTENANCE

Perform the following at least twice a year:

- Lubricate hinges and gaskets. Wipe off all excess lubricant.
- Make sure the unit is levelled. If necessary, adjust castors/feet.
- Inspect all seals and gaskets. Make sure they are still soft and flexible.
- Check the battery with a voltmeter – should only be performed by authorized personal and according to the service manual which is available on our website.

- Battery used is 12V 7.2Ah Rechargeable Lead Acid Battery – do not use any other battery than stated in the manual. For more information contact Arctiko Service. Battery must be recycled.



WARNING

Before any inspection or maintenance work is performed, the power cord of the unit should be disconnected from the power outlet. This is to prevent any potential electrical shock or injury. During the maintenance work, do not breathe the dust and aerosols near the unit, they might be harmful to your health.

CLEANING

Perform the following instructions at least once a month:

- Always keep the unit free of ice. Use a soft cloth or brush to remove loose ice. Never use sharp tools and be cautious not to damage the gaskets. Keeping the unit free of ice will extend it's lifespan.
- Clean the outside and inside of the unit using a dry, soft cloth or brush or a soft cloth with a solution of water and mild detergent. If a thorough cleaning or disinfection is required, we recommend using ethanol.
- Clean all gaskets using a damp cloth and, if necessary, a mild detergent. Remove dirt and wipe with a dry cloth afterwards. Do not pour water directly into the unit. By doing so, the water can damage the insulation materials and electrical components.
- Dust off the inside of the compressor compartment using only a dry brush or a vacuum cleaner. Parts of the refrigeration system of this unit are completely sealed. These do not require any lubrication.



ATTENTION

Do not use abrasive nor chlorine-containing products to clean the unit.



ATTENTION

Components in the compressor department may be hot e.g. compressors and/or fan motor.

DEFROSTING

It is recommended to defrost this unit twice a year. This unit does not have automatic defrost, therefore you have to perform defrosting by following these instructions:

1. If the unit is loaded with products, move these to another unit to maintain the temperature of the products.
2. Turn off the unit on the display by pressing the **STANDBY** button.
3. Unplug the power cord from the power outlet.
4. Open the door of the unit.
5. Place cloths or towels in the bottom of the unit to collect and limit defrost water.
6. Leave the unit open for a minimum of 24 hours allowing the ice to melt.
7. When the defrosting is completed, thoroughly clean the unit inside. Wipe off all remaining water and leave the door open until the cabinet is completely dry.
8. Connect the power cord to the power outlet and switch on the unit on the display by pressing the **ON/OFF** button.
9. Reload the unit after reaching the set temperature (pull down).

SERVICE

Arctiko recommends that service is performed by authorized service personnel at least once a year. Contact your Arctiko distributor for contact information. Always have the serial number of the unit and model ready for the distributor.

SPARE PARTS

For requirements of spare parts, contact your Arctiko distributor. Please inform the serial number

of the unit and model when contacting the distributor.

Arctiko strive for day-to-day delivery of spare parts. However, some special parts may take longer due to production time. Arctiko guarantees availability of spare parts for all units for at least 10 years after the delivery.

AFTER-SALES

If you would like more information about your device or you would like to purchase spare parts or additional equipment, please contact your local distributor. Always have serial number of the unit and model handy when contacting the distributor.

WARRANTY

For warranty information, Arctiko refers to your distributors terms and conditions.

TROUBLESHOOTING

Most malfunctions arise in wrong use of the unit and can often be solved on the spot. In order to resolve some of the most common malfunctions please see the following troubleshooting scheme:

PROBLEM	CAUSE	ACTION
The refrigeration of the unit is not effective, temperature tends to operate out of range.	Overload or load of warm products may cause the temperature to rise.	Discharge warm or excess products.
	Products are packed too close in the unit, preventing air to flow.	Relocate the products. Make sure there is an air gap between products.
	Make sure the unit is not in direct sunlight or subject to any heat radiation.	Move the unit away from the sunlight or heat source.
	Frequent door openings may cause the temperature to rise.	Check if there has been frequent door openings. Leave the door closed until the temperature in the unit is stable.
	The ambient temperature is too high. The unit is most effective in an environment under 25°C.	Control the room temperature in the room where the unit is located.
The unit is too noisy.	The unit is not levelled.	Adjust the castors/feet.
	The unit is touching a wall or object.	Move the unit away from the wall or objects.
	Warm products are loaded into the unit. The alarm signal cancels when the temperature recovers to normal level.	Allow time for the temperature to recover. The alarm will stop when the temperature has recovered.
Alarm light flashes, audible alarm sounds.	Door is not shut properly. The Door alarm will sound if the door is even slightly opened.	Shut the door.
	Unstable power supply might cause the alarm to switch on.	Allow time for recovery.

NOTES



ARCTIKO A/S | Oddesundvej 39 | 6715 Esbjerg N | Denmark
+45 70 20 03 28 | www.arctiko.com | info@arctiko.com

Follow us on:



We reserve the right to change specifications without notice. Subject to confirmation, availability and errors.
Check our website for further technical information.



5080068 - 05 - GB