

TOP VIEW

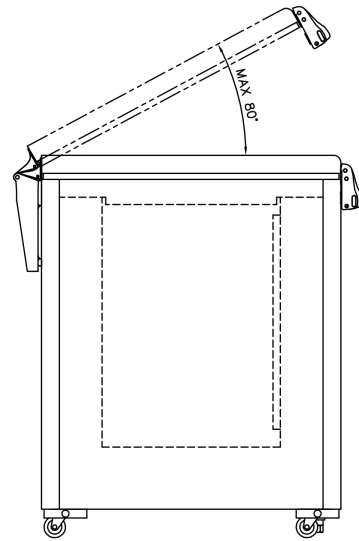

LEFT VIEW

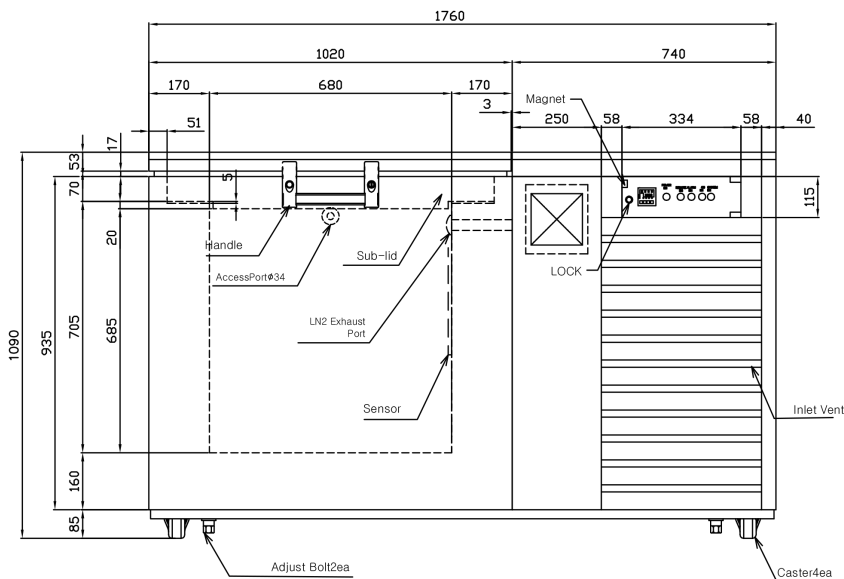

FRONT VIEW

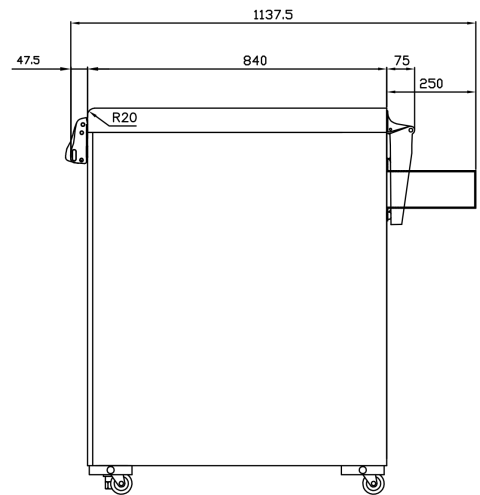

RIGHT VIEW

Description: Dimension Drawing CRYO 230



Drawing no.: 5088107

Revision: 05

Drawing (initials): DBL

Date: 201208

Approval (initials): MET

Date: 201208

All rights to this drawing belong to Arctiko A/S. The drawing may not be copied nor presented to any other person without prior written consent of Arctiko A/S.